

MF700PN (PNEUMATIC TRAINER) PARTS LIST CATALOG

SEPTEMBER 2015



MF700PN PNEUMATIC SYSTEM TRAINER

NOTE: Asterisk (*) in front of a part number indicates a component required to construct the most basic circuit.

WORKSTATION ASSEMBLY

FRAME ASSEMBLY

NOTE: *SINGLE station and DUAL station trainers use the same frame assembly (shown with panels)*

Includes:

- Four (4) wheel casters w/brakes
- Component storage compartment
- Electrical box w/receptacle plugs
- Writing station
- Hose caddy
- All-aluminum frame finished with Satin black powder-coating

P/N: *MF700PN-FA



WORKSTATION PANEL

Includes all mounting hardware.

Mount components vertically or horizontally with FPTI™'s unique component mounting design.

NOTE: *Two (2) panels required for a DUAL station trainer*

P/N: *MF700PN-02

SPECIFICATIONS -

Dimensions: 50.0" x 35.0"
(1270mm x 889mm).

Weight: 28 lbs (12.7 kg).

Quantity required: One (1) for a SINGLE trainer
Two (2) for a DOUBLE trainer



AIR COMPRESSOR

P/N: MF700PN-AC

SPECIFICATIONS -

| | |
|----------------------|--|
| Capacity: | 2.6 gallon. 2.0 HP 3.3 CFM @ 90 PSI |
| Pressure: | 130 PSI (8.96 bar) - maximum @ 1720 RPM |
| Electrical: | 120 VAC. 12.4 amps |
| Sound Rating: | 40 decibels |



ANSI/ISO SYMBOL:

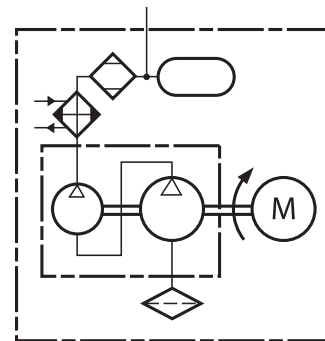

NOTE: *Items shown in this catalog may be different to those actually offered. FPTI™ reserves the right to substitute items shown with items of similar or higher quality.*

ROLLER-OPERATED - 2-position, 3-way

P/N: *MF700PN-40421-1000

SPECIFICATIONS -

Type of actuation: Roller-operated.
Spool centering: Spring-centered.
Mounting type: Sub-plate mounted.
Connections: Two (2) quick-couplers.
Additional feature: Muffler/Filter.
 ANSI/ISO symbol tag.

Quantity required: Two (2) per panel/side

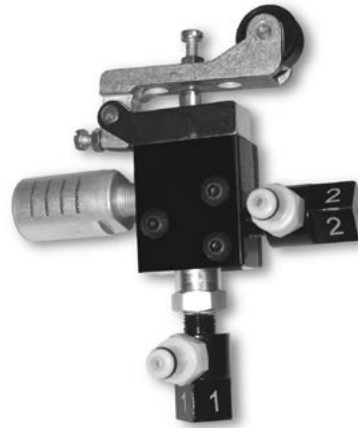

ANSI/ISO SYMBOL:

- Roller-operated
- 2-position
- 3-way
- Spring-centered
- Subplate-mounted
- Two (2) quick-couplers

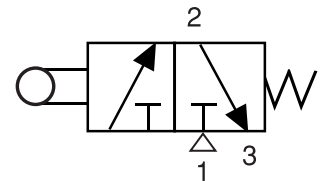

TRIP LEVER-OPERATED - 2-position, 3-way

P/N: MF700PN-40431-1000

SPECIFICATIONS -

Type of actuation: One-way Trip lever.
Spool centering: Spring-centered.
Mounting type: Sub-plate mounted.
Connections: Two (2) quick-couplers.
Additional feature: Muffler/Filter.
 ANSI/ISO symbol tag.

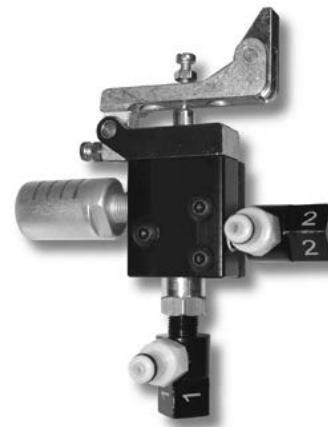

ANSI/ISO SYMBOL:

- Trip lever-operated
- 2-position
- 3-way
- Spring-centered
- Subplate-mounted
- Two (2) quick-couplers

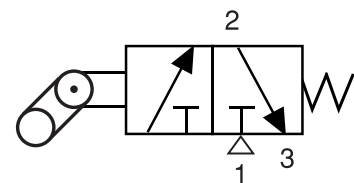

***PUSH BUTTON-OPERATED
NORMALLY CLOSED - 2-position, 3-way***

P/N: MF700PN-41441-1000

SPECIFICATIONS -

- Type of actuation:** Push button.
- Spool centering:** Spring-centered.
- Mounting type:** Sub-plate mounted.
- Connections:** Two (2) quick-couplers.
- Additional feature:** Muffler/Filter.
ANSI/ISO symbol tag.



ANSI/ISO SYMBOL:

- Push button-operated
- 2-position
- 3-way
- Spring-centered
- Subplate-mounted
- Two (2) quick-couplers

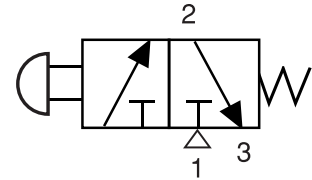

***PUSH BUTTON-OPERATED
NORMALLY OPEN - 2-position, 3-way***

P/N: MF700PN-41441-1000-OP

SPECIFICATIONS -

- Type of actuation:** Push button.
- Spool centering:** Spring-centered.
- Mounting type:** Sub-plate mounted.
- Connections:** Two (2) quick-couplers.
- Additional feature:** Muffler/Filter.
ANSI/ISO symbol tag.



ANSI/ISO SYMBOL:

- Push button-operated
- 2-position
- 3-way
- Spring-centered
- Subplate-mounted
- Two (2) quick-couplers

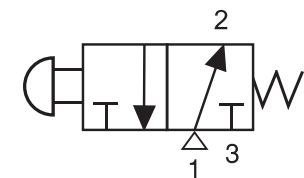

PUSH BUTTON-OPERATED- 2-position, 5-way

P/N: MF700PN-41041-1000

SPECIFICATIONS -

- Type of actuation:** Hand Lever-operated.
- Spool centering:** Spring-centered.
- Mounting type:** Sub-plate mounted.
- Connections:** Three (3) quick-couplers.
- Additional feature:** Muffler/Filter.
ANSI/ISO symbol tag.

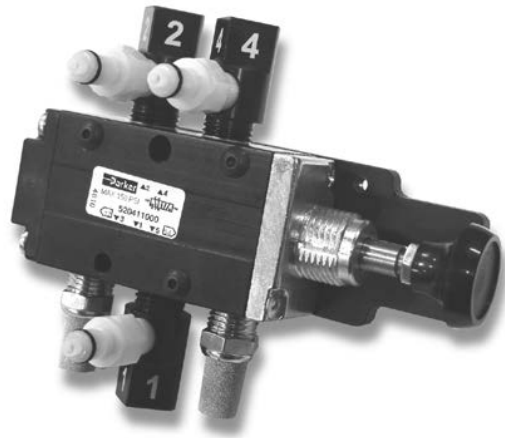

ANSI/ISO SYMBOL:

- Push button-operated
- 2-position
- 5-way
- Spring-centered
- Subplate-mounted
- Three (3) quick-couplers

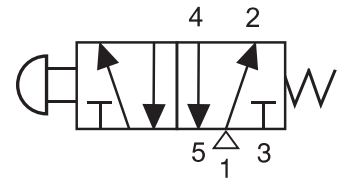

HAND LEVER-OPERATED - 2-position, 3-way

P/N: *MF700PN-52481-1000

SPECIFICATIONS -

- Type of actuation:** Hand Lever-operated.
- Spool centering:** Spring-centered.
- Mounting type:** Sub-plate mounted.
- Connections:** Two (2) quick-couplers.
- Additional feature:** Muffler/Filter.
ANSI/ISO symbol tag.

Quantity required: One (1) per panel/side



ANSI/ISO SYMBOL:

- Hand lever-operated
- 2-position
- 3-way
- Spring-centered
- Subplate-mounted
- Two (2) quick-couplers

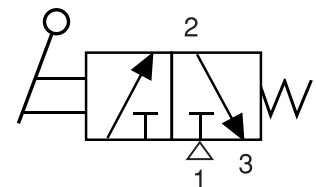

HAND LEVER-OPERATED - 2-position, 3-way

P/N: MF700PN-52483-1000

SPECIFICATIONS -

- Type of actuation:** Hand Lever-operated.
Spool centering: Detent manual return.
Mounting type: Sub-plate mounted.
Connections: Two (2) quick-couplers.
Additional feature: Muffler/Filter.
ANSI/ISO symbol tag.



ANSI/ISO SYMBOL:

- Hand lever-operated
- 2-position
- 3-way
- Detent manual return
- Subplate-mounted
- Two (2) quick-couplers

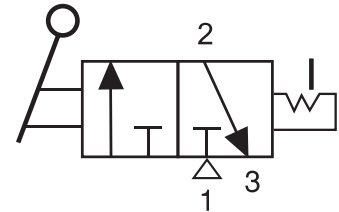

DIRECTIONAL CONTROL VALVES - PILOT-OPERATED

SINGLE REMOTE PILOT NORMALLY CLOSED - 2-position, 3-way

P/N: MF700PN-EZ2KN000YYA

SPECIFICATIONS -

Type of actuation: Single remote pilot.
Spool centering: Air-return.
Mounting type: Sub-plate mounted.
Connections: Two (2) quick-couplers.
Additional feature: Muffler/Filter.
ANSI/ISO symbol tag.

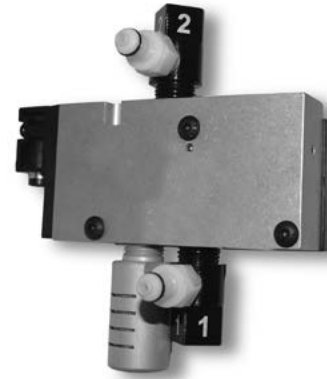

ANSI/ISO SYMBOL:

- Single remote pilot
- Normally closed
- 2-position
- 3-way
- Air-return
- Subplate-mounted
- Two (2) quick-couplers

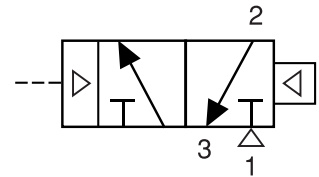

SINGLE REMOTE PILOT NORMALLY OPEN - 2-position, 3-way

P/N: MF700PN-EZ2LN000YYA

SPECIFICATIONS -

Type of actuation: Single remote pilot.
Spool centering: Air-return.
Mounting type: Sub-plate mounted.
Connections: Two (2) quick-couplers.
Additional feature: Muffler/Filter.
ANSI/ISO symbol tag.



ANSI/ISO SYMBOL:

- Single remote pilot
- Normally open
- 2-position
- 3-way
- Air-return
- Subplate-mounted
- Two (2) quick-couplers

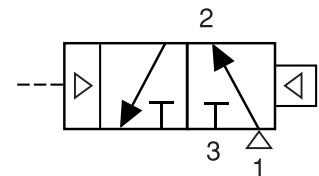

DIRECTIONAL CONTROL VALVES - PILOT-OPERATED

SINGLE REMOTE PILOT - 2-position, 5-way

P/N: *MF700PN-EZ23N000YYA

SPECIFICATIONS -

Type of actuation: Single remote pilot.
Spool centering: Air-return.
Mounting type: Sub-plate mounted.
Connections: Three (3) quick-couplers.
Additional feature: Two (2) Muffler/Filters.
 ANSI/ISO symbol tag.

Quantity required: One (1) per panel/side



ANSI/ISO SYMBOL:

- Single remote pilot
- 2-position
- 5-way
- Air-return
- Subplate-mounted
- Three (3) quick-couplers

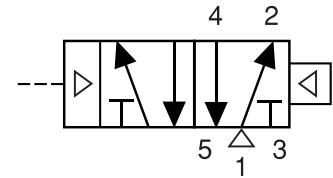

DOUBLE REMOTE PILOT - 2-position, 5-way

P/N: MF700PN-EZ24N000YYA

SPECIFICATIONS -

Type of actuation: Double remote pilot.
Mounting type: Sub-plate mounted.
Connections: Three (3) quick-couplers.
Additional feature: Two (2) Muffler/Filters.
 ANSI/ISO symbol tag.



ANSI/ISO SYMBOL:

- Double remote pilot
- 2-position
- 5-way
- Subplate-mounted
- Three (3) quick-couplers

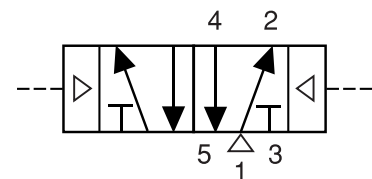

DIRECTIONAL CONTROL VALVES - PILOT-OPERATED

DOUBLE REMOTE PILOT - 3-position, 5-way

P/N: MF700PN-EZ28N000YYA

SPECIFICATIONS -

Type of actuation: Double remote pilot.
Spool centering: Spring-centered.
Mounting type: Sub-plate mounted.
Connections: Three (3) quick-couplers.
Additional feature: Muffler/Filter.
ANSI/ISO symbol tag.



ANSI/ISO SYMBOL:

- Double remote pilot
- 3-position
- 5-way
- Spring-centered
- Subplate-mounted
- Three (3) quick-couplers

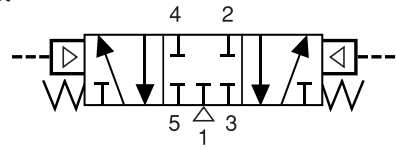

DIRECTIONAL CONTROL VALVES - SOLENOID-OPERATED

SINGLE SOLENOID NORMALLY CLOSED - 2-position, 3-way

P/N: *MF700PN-EZ2GNBB549A

SPECIFICATIONS -

Type of actuation: Single solenoid-operated.
Spool centering: Air-return.
Mounting type: Sub-plate mounted.
Connections: Two (2) quick-couplers.
Additional feature: Muffler/Filter.
 ANSI/ISO symbol tag.

Quantity required: One (1) per panel/side



ANSI/ISO SYMBOL:

- Single solenoid
- Normally closed
- 2-position
- 3-way
- Air-return
- Subplate-mounted
- Two (2) quick-couplers

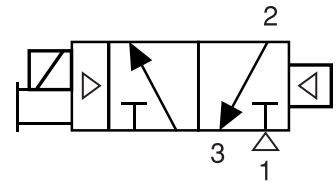

SINGLE SOLENOID NORMALLY OPEN - 2-position, 3-way

P/N: MF700PN-EZ2HNBB549A

SPECIFICATIONS -

Type of actuation: Single solenoid-operated.
Spool centering: Air-return.
Mounting type: Sub-plate mounted.
Connections: Two (2) quick-couplers.
Additional feature: Muffler/Filter.
 ANSI/ISO symbol tag.



ANSI/ISO SYMBOL:

- Single solenoid
- Normally open
- 2-position
- 3-way
- Air-return
- Subplate-mounted
- Two (2) quick-couplers

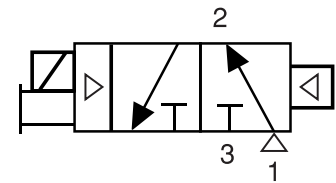

DIRECTIONAL CONTROL VALVES - SOLENOID-OPERATED

SINGLE SOLENOID - 2-position, 3-way

P/N: MF700PN-EZ21NBB549A

SPECIFICATIONS -

Type of actuation: Single solenoid-operated.
Spool centering: Air-return.
Mounting type: Sub-plate mounted.
Connections: Two (2) quick-couplers.
Additional feature: Muffler/Filter.
 ANSI/ISO symbol tag.



ANSI/ISO SYMBOL:

- Single solenoid
- 2-position
- 3-way
- Air-return
- Subplate-mounted
- Two (2) quick-couplers

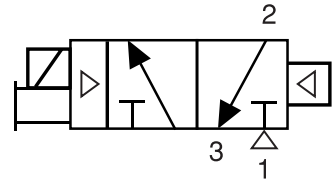

DOUBLE SOLENOID - 2-position, 5-way

P/N: MF700PN-EZ22NBB549A

SPECIFICATIONS -

Type of actuation: Double solenoid-operated.
Mounting type: Sub-plate mounted.
Connections: Three (3) quick-couplers.
Additional feature: Muffler/Filter.
 ANSI/ISO symbol tag.



ANSI/ISO SYMBOL:

- Double solenoid
- 2-position
- 5-way
- Subplate-mounted
- Three (3) quick-couplers

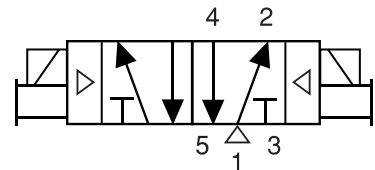

DIRECTIONAL CONTROL VALVES - SOLENOID-OPERATED

DOUBLE SOLENOID - 3-position, 5-way

P/N: *MF700PN-EZ25NBB549A

SPECIFICATIONS -

Type of actuation: Double solenoid-operated.
Spool centering: Spring-centered.
Mounting type: Sub-plate mounted.
Connections: Three (3) quick-couplers.
Additional feature: Muffler/Filter.
ANSI/ISO symbol tag.

Quantity required: One (1) per panel/side

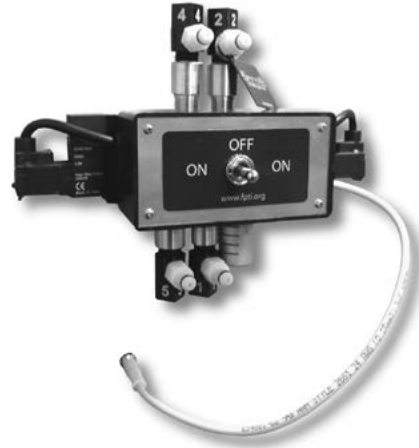

ANSI/ISO SYMBOL:

- Double solenoid
- 3-position
- 5-way
- Spring-centered
- Subplate-mounted
- Three (3) quick-couplers

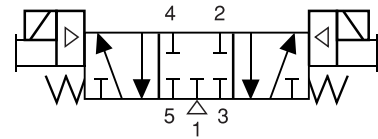

FLOW CONTROL VALVES

INLINE FLOW CONTROL VALVE

P/N: *MF700PN-FC806-2

SPECIFICATIONS -

- Adjustment type:** Knob.
Mounting type: Plate mounted.
Connections: Two (2) quick-couplers.
Additional feature: ANSI/ISO symbol tag.

Quantity required: Four (4) per panel/side



ANSI/ISO SYMBOL:

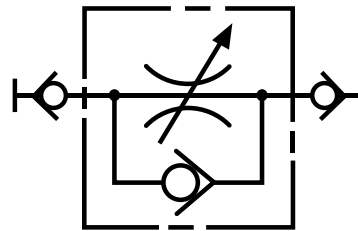

CHECK VALVE

P/N: MF700PN-003393000

SPECIFICATIONS -

- Construction:** Brass body.
Stainless steel poppet.
Operating Pressure: 250 PSIG (max.)
Operating Temp.: **0° to 140° F.
Mounting type: Plate mounted.
Connections: Two (2) quick-couplers.
Additional feature: ANSI/ISO symbol tag.

** Ambient temperatures below freezing require moisture-free air. Ambient temperatures below freezing and above 180° require lubricants especially selected for suitability at these temperatures. Pneumatic valves should be used with filtered and lubricated air.



ANSI/ISO SYMBOL:

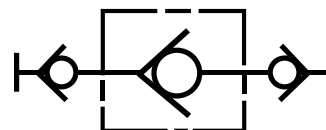

ACTUATORS

CYLINDER

Double-acting, single rod

P/N: *MF700PN-1.50-DX-SR-10

SPECIFICATIONS -

Bore: 1.5" (38mm).
Stroke: 10" (254mm).
Construction: Stainless steel piston rods and double-rolled unitized body construction.
Standard Option: Pressure gauge ports.
Mounting: Plate mounted.
Connections: Two (2) quick-couplers.
Additional feature: ANSI/ISO symbol tag.
Quantity required: One (1) per panel/side



ANSI/ISO SYMBOL:

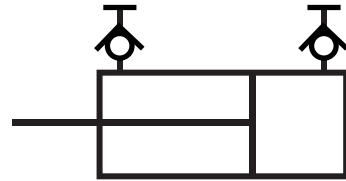

CYLINDER

Single-acting, single rod, spring-return

P/N: *MF700PN-1.50-NRP-SR-6

SPECIFICATIONS -

Bore: 1.5" (38mm).
Stroke: 6" (152.4mm).
Construction: Stainless steel piston rods and double-rolled unitized body construction.
Standard Option: Pressure gauge ports.
Mounting: Plate mounted.
Connections: One (1) quick-coupler.
Additional feature: ANSI/ISO symbol tag.
Quantity required: Two (2) per panel/side



ANSI/ISO SYMBOL:

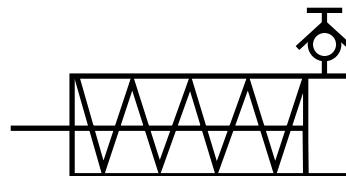

ACTUATORS

CYLINDER

Single-acting, single rod pencil cylinder

P/N: MF700PN-0.44-NR-SR-3.5

SPECIFICATIONS -

Bore: 7/16" (11.2mm).
Stroke: 3.5" (89mm).
Construction: Stainless steel piston rods and double-rolled unitized body construction.
Standard Option: Pressure gauge ports.
Mounting: Plate mounted.
Connections: One (1) hose-coupler.
Additional feature: ANSI/ISO symbol tag.



ANSI/ISO SYMBOL:

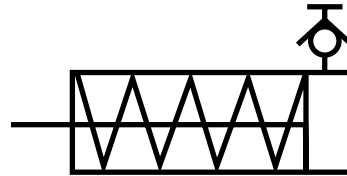

COMPONENTS

FILTER/REGULATOR/E-STOP COMBO 1/4" NPT INPUT COUPLER

P/N: *MF700PN-P31EA92EGMBN5P

SPECIFICATIONS -

Operating Pressure: Max. 150 PSIG (1000 KPa).

Operating Temp.: **125° F (52° C).

Additional feature: Muffler/Filter.
ANSI/ISO symbol tag.

Quantity required: One (1) per panel/side

** Ambient temperatures below freezing require moisture-free air. Ambient temperatures below freezing and above 180° require lubricants especially selected for suitability at these temperatures. Pneumatic valves should be used with filtered and lubricated air.



ANSI/ISO SYMBOL:

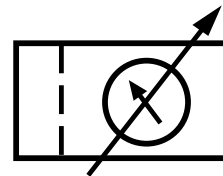

QUICK EXHAUST

1/8" NPT

P/N: *MF700PN-OR12B

SPECIFICATIONS -

Operating Pressure: Max. 150 PSIG (1000 KPa).

Min. 3 PSI (20 KPa).

Operating Temp.: **0° to 180° F (-18° to 80° C).

Additional feature: Muffler/Filter.
ANSI/ISO symbol tag.

Quantity required: One (1) per panel/side

** Ambient temperatures below freezing require moisture-free air. Ambient temperatures below freezing and above 180° require lubricants especially selected for suitability at these temperatures. Pneumatic valves should be used with filtered and lubricated air.



ANSI/ISO SYMBOL:

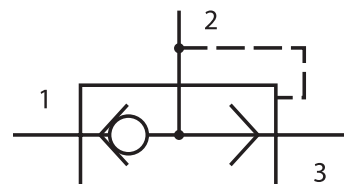

COMPONENTS

MUFFLER/FILTER

1/8" NPT and 1/4" NPT

P/N: MF700PN-ES12MC (1/8" NPT)

P/N: MF700PN-ES25MC (1/4" NPT)

SPECIFICATIONS -

Pipe thread: 1/8" NPT and 1/4" NPT.

Operating Pressure: Max. 250 PSIG (Air).

Operating Temp.: **0° to 300° F (0° to 149° C)

** Ambient temperatures below freezing require moisture-free air. Ambient temperatures below freezing and above 180° require lubricants especially selected for suitability at these temperatures. Pneumatic valves should be used with filtered and lubricated air.



ANSI/ISO SYMBOL:



PRESSURE GAUGE

0 - 150 PSI

P/N: *MF700PN-PG-150

SPECIFICATIONS -

Size: 1.5" (38mm) dia. face.

Case material: Plastic.

Connections: One (1) quick-coupler.

Quantity required: Three (3) per panel/side



ANSI/ISO SYMBOL:

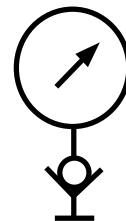

PRE-MADE PNEUMATIC TUBING

30" (762 mm) Length

P/N: *MF700PN-HA-30

SPECIFICATIONS -

Tube type: Blue plastic
Size: 1/4" (6.35mm)
Length: 30" (762mm)
Tube end fittings: PPM121-2-MP

Quantity required: Eight (8) per panel/side



ANSI/ISO SYMBOL:

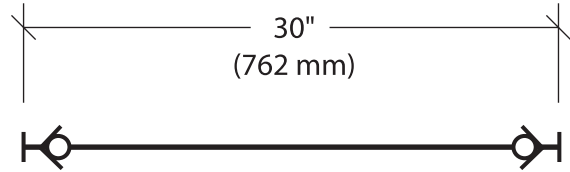

PNEUMATIC TUBING

100' roll (30.48 m)

P/N: *MF700PN-PE0417-100-B

SPECIFICATIONS -

Tube type: Blue plastic
Size: 1/4" (6.35mm)

Quantity required: 100 ft (30.48m)
per panel/side



PNEUMATIC TUBING CUTTER

P/N: *MF700PN-TC-1

Quantity required: One (1) per panel/side



TUBE END FITTING/FEMALE QD

P/N: *MF700PN-PPM121-2-MP

SPECIFICATIONS -

Size: 1/4" Tube.

Quantity required: Twenty (20) per panel/side



TUBE END FITTING/MALE QD

P/N: MF700PN-PPM122-2-MP

SPECIFICATIONS -

Size: 1/4" Tube.



TEE FITTING

P/N: *MF700PN-364-PL-4

SPECIFICATIONS -

Size: 1/4" x 1/4" x 1/4"

Quantity: Ten (10) recommended.

Quantity required: Ten (10) per panel/side



TRAINING LITERATURE and MATERIALS

STUDENT TRAINER ACTIVITIES

(one per student recommended)

P/N: *HC-R007-TA

POWERPOINT CD-ROM & INSTRUCTOR GUIDE

(one per instructor recommended)

P/N: *HC-R007-TAi

THE LETHAL STRIKE -

Procedures for Properly Managing Injection Injuries DVD

P/N: HC-FPSI-001DVD

**MF700PN
(PNEUMATICS TRAINER)
PARTS LIST/ORDER FORM**

MF700PN PNEUMATIC SYSTEM TRAINER

WORKSTATION ASSEMBLY

| ITEM DESCRIPTION | PART No. | QTY |
|---|-----------------------|--------------------------|
| FRAME ASSEMBLY Same frame for SINGLE or DUAL station. | *MF700PN-FA | <input type="checkbox"/> |
| WORKSTATION PANEL Includes all mounting hardware. | *MF700PN-02 | <input type="checkbox"/> |
| AIR COMPRESSOR | MF700PN-AC | <input type="checkbox"/> |
| DIRECTIONAL CONTROL VALVES - <i>MANUAL</i> | | |
| ROLLER-OPERATED - 2-position, 3-way | *MF700PN-40421-1000 | <input type="checkbox"/> |
| TRIP LEVER-OPERATED - 2-position, 3-way | MF700PN-40431-1000 | <input type="checkbox"/> |
| PUSH BUTTON-OPERATED - (NORMALLY CLOSED) 2-position, 3-way | MF700PN-41441-1000 | <input type="checkbox"/> |
| PUSH BUTTON-OPERATED - (NORMALLY OPEN) 2-position, 3-way | MF700PN-41441-1000-OP | <input type="checkbox"/> |
| PUSH BUTTON-OPERATED - 2-position, 4-way | MF700PN-41041-1000 | <input type="checkbox"/> |
| HAND LEVER-OPERATED - 2-position, 3-way | *MF700PN-52481-1000 | <input type="checkbox"/> |
| HAND LEVER-OPERATED - 2-position, 3-way with Detent position | MF700PN-52483-1000 | <input type="checkbox"/> |
| DIRECTIONAL CONTROL VALVES - <i>PILOT-OPERATED</i> | | |
| SINGLE REMOTE PILOT (NORMALLY CLOSED) 2-position, 3-way | MF700PN-EZ2KN000YYA | <input type="checkbox"/> |
| SINGLE REMOTE PILOT (NORMALLY OPEN) 2-position, 3-way | MF700PN-EZ2LN000YYA | <input type="checkbox"/> |
| SINGLE REMOTE PILOT 2-position, 4-way | *MF700PN-EZ23N000YYA | <input type="checkbox"/> |

MF700PN PNEUMATIC SYSTEM TRAINER

DIRECTIONAL CONTROL VALVES - PILOT-OPERATED (cont'd)

| ITEM DESCRIPTION | PART No. | QTY |
|---|------------------------|--------------------------|
| DOUBLE REMOTE PILOT 2-position, 5-way | MF700PN-EZ24N000YYA | <input type="checkbox"/> |
| DOUBLE REMOTE PILOT 3-position, 5-way | MF700PN-EZ28N000YYA | <input type="checkbox"/> |
| DIRECTIONAL CONTROL VALVES - SOLENOID-OPERATED | | |
| SINGLE SOLENOID (NORMALLY CLOSED) 2-position, 3-way | *MF700PN-EZ2GNBB549A | <input type="checkbox"/> |
| SINGLE SOLENOID (NORMALLY OPEN) 2-position, 3-way | MF700PN-EZ2HNBB549A | <input type="checkbox"/> |
| SINGLE SOLENOID 2-position, 3-way | MF700PN-EZ21NBB549A | <input type="checkbox"/> |
| DOUBLE SOLENOID 2-position, 5-way | MF700PN-EZ22NBB549A | <input type="checkbox"/> |
| DOUBLE SOLENOID 3-position, 5-way | *MF700PN-EZ25NBB549A | <input type="checkbox"/> |
| FLOW CONTROL VALVES | | |
| INLINE FLOW CONTROL VALVE | *MF700PN-FC806-2 | <input type="checkbox"/> |
| CHECK VALVE | MF700PN-003393000 | <input type="checkbox"/> |
| ACTUATORS | | |
| PNEUMATIC CYLINDER Double-acting, single rod | *MF700PN-1.50-DX-SR-10 | <input type="checkbox"/> |
| PNEUMATIC CYLINDER Single-acting, single rod, spring-return | *MF700PN-1.50-NRP-SR-6 | <input type="checkbox"/> |
| PNEUMATIC CYLINDER Single-acting, single rod, pencil cylinder | MF700PN-0.44-NR-SR-3.5 | <input type="checkbox"/> |

MF700PN PNEUMATIC SYSTEM TRAINER

COMPONENTS

| ITEM DESCRIPTION | PART No. | QTY |
|--|-------------------------|--------------------------|
| FILTER/REGULATOR/E-STOP COMBO 1/4" NPT INPUT COUPLER | *MF700PN-P31EA92EGMBN5P | <input type="checkbox"/> |
| QUICK EXHAUST 1/8" NPT | *MF700PN-OR12B | <input type="checkbox"/> |
| MUFFLER/FILTER 1/8" NPT | MF700PN-ES12MC | <input type="checkbox"/> |
| MUFFLER/FILTER 1/4" NPT | MF700PN-ES25MC | <input type="checkbox"/> |
| PRESSURE GAUGE 150 PSI | *MF700PN-PG150 | <input type="checkbox"/> |
| AIR HOSE / FITTINGS / CONNECTORS / ACCESSORIES | | |
| PRE-MADE PNEUMATIC TUBING 30" (762 mm) Length | *MF700PN-HA-30 | <input type="checkbox"/> |
| PNEUMATIC TUBING 100' roll (30.48 m) | *MF700PN-PE0417-100-B | <input type="checkbox"/> |
| PNEUMATIC TUBING CUTTER | *MF700PN-TC-1 | <input type="checkbox"/> |
| TUBE END FITTING/FEMALE QD | *MF700PN-PPM121-2MP | <input type="checkbox"/> |
| MALE QD | MF700PN-PPM122-2MP | <input type="checkbox"/> |
| TEE FITTING | *MF700PN-364-PL-4 | <input type="checkbox"/> |
| TRAINING LITERATURE & MATERIALS | | |
| STUDENT TRAINER ACTIVITIES | *HC-R007-TA | <input type="checkbox"/> |
| POWERPOINT CD-ROM & INSTRUCTOR GUIDE | *HC-R007-TAi | <input type="checkbox"/> |
| THE LETHAL STRIKE - Procedures for Properly Managing Injection Injuries DVD | HC-FPSI-001DVD | <input type="checkbox"/> |

Distributed by:



2170 South 3140 West
West Valley City, UT 84119
PH: 801.908.5456
FX: 801.908.5734

<http://www.fpti.org>