

H2Hybrid - Fuel Cell Automotive Trainer SET



- **Advanced Fuel Cell Education**
- **Hydrogen Hybrid Technology**
- **Advanced Curriculum With Computer Modeling**





H2Hybrid Fuel Cell Automotive Trainer

UNDERSTAND HYBRID VEHICLES LIKE NEVER BEFORE

The H2Hybrid Fuel Cell Automotive Trainer is the ultimate tool for exploring science and engineering concepts through hands-on activities with a working fuel cell car. An impressive array of hardware, software, and digital curricular materials allow for hours of activities for students from high school vocational-technical up through college-level engineering.

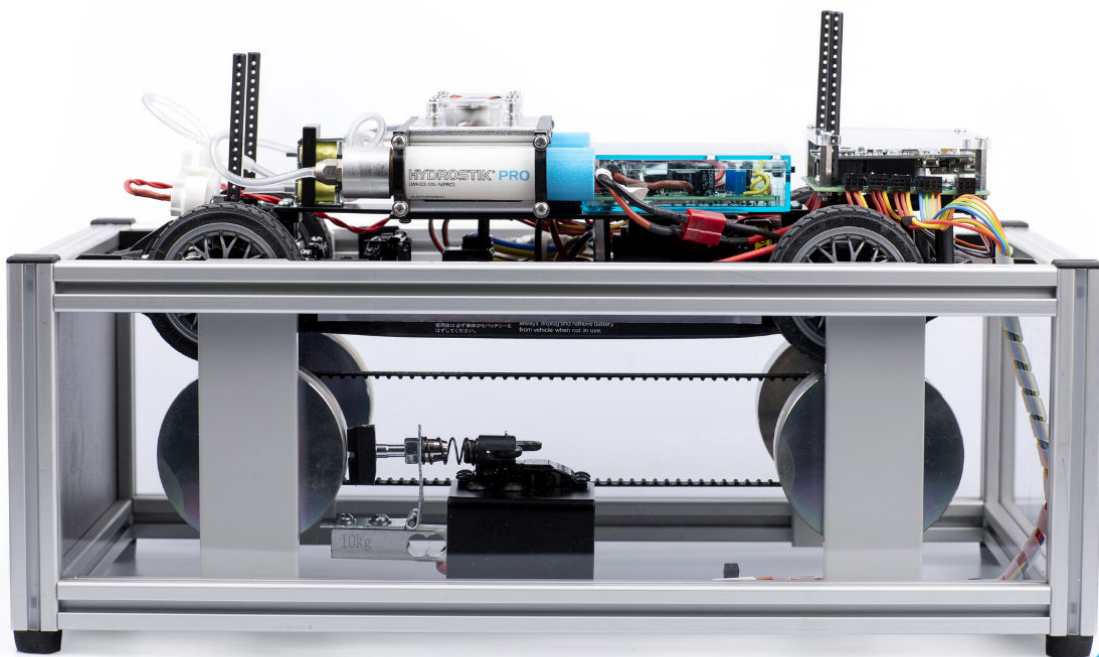

AREAS OF STUDY

- ✓ Engineer new solutions for optimization of car's performance
- ✓ Examine the three fields of energy management
- ✓ Comprehend hybrid propulsion technology and work to minimize environmental impacts
- ✓ Learn about data acquisition and discover how to manipulate, analyze and interpret graphs and data gathered from the car on the road and on the bench
- ✓ Understand the expected performance of a fuel cell system and how to get to optimum operation
- ✓ Explore the difference between expected performance and experimental results



INCLUDED COMPONENTS

30W FUEL CELL CAR

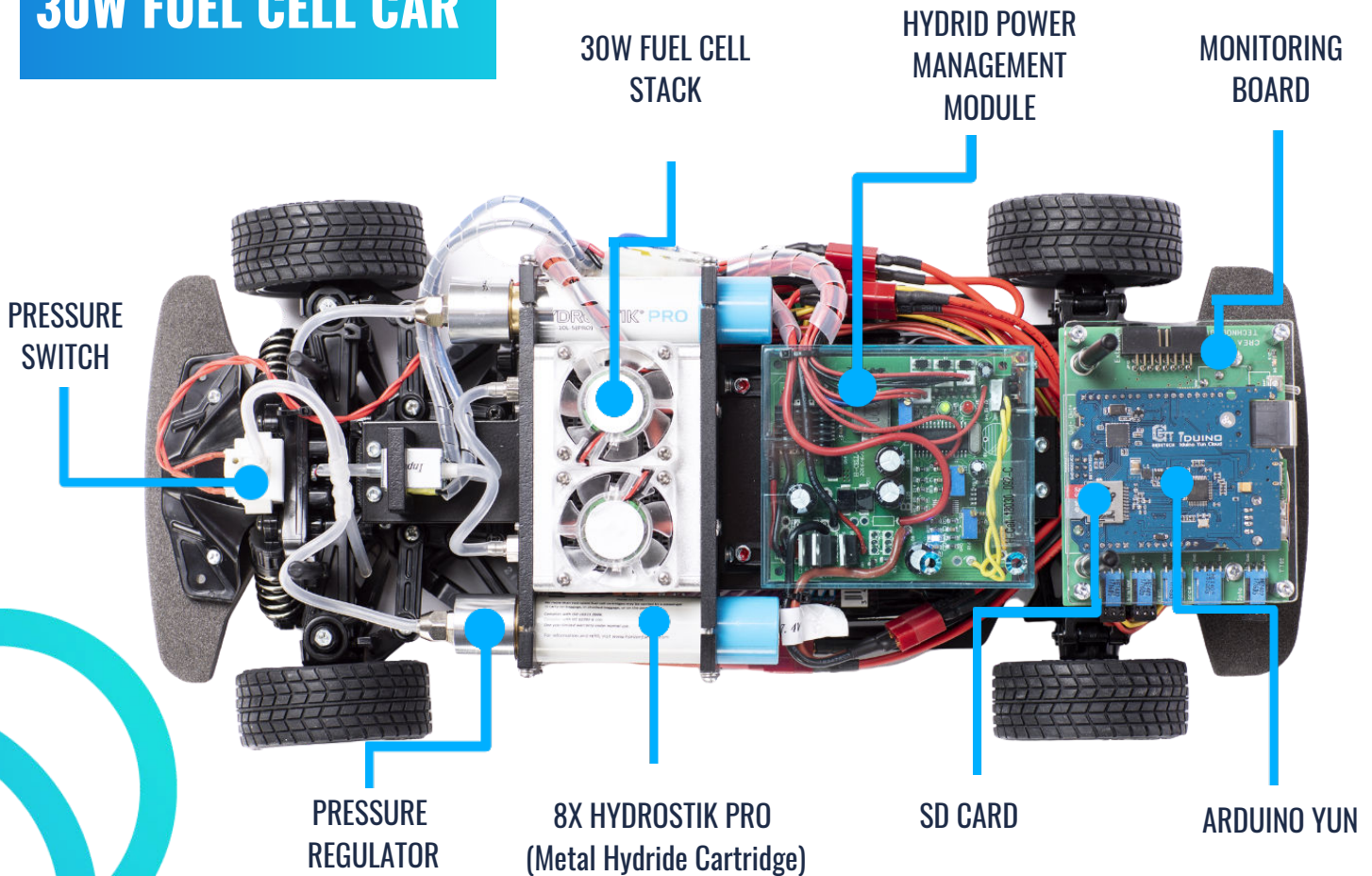

MONITORING BOARD

- ✓ Arduino YUN board with HTML WEB server interface
- ✓ Measure voltage and current from the motor, fuel cell and battery, as well as distance travelled
- ✓ Included SD card stores the data as a .csv file
- ✓ Data can also be transferred in real time to PC for analysis

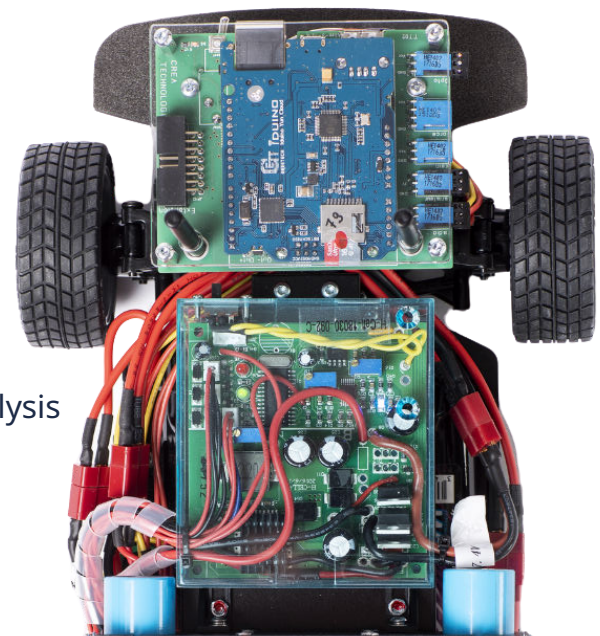



H2Hybrid Fuel Cell Automotive Trainer

FEATURES

ROLLER TEST BENCH

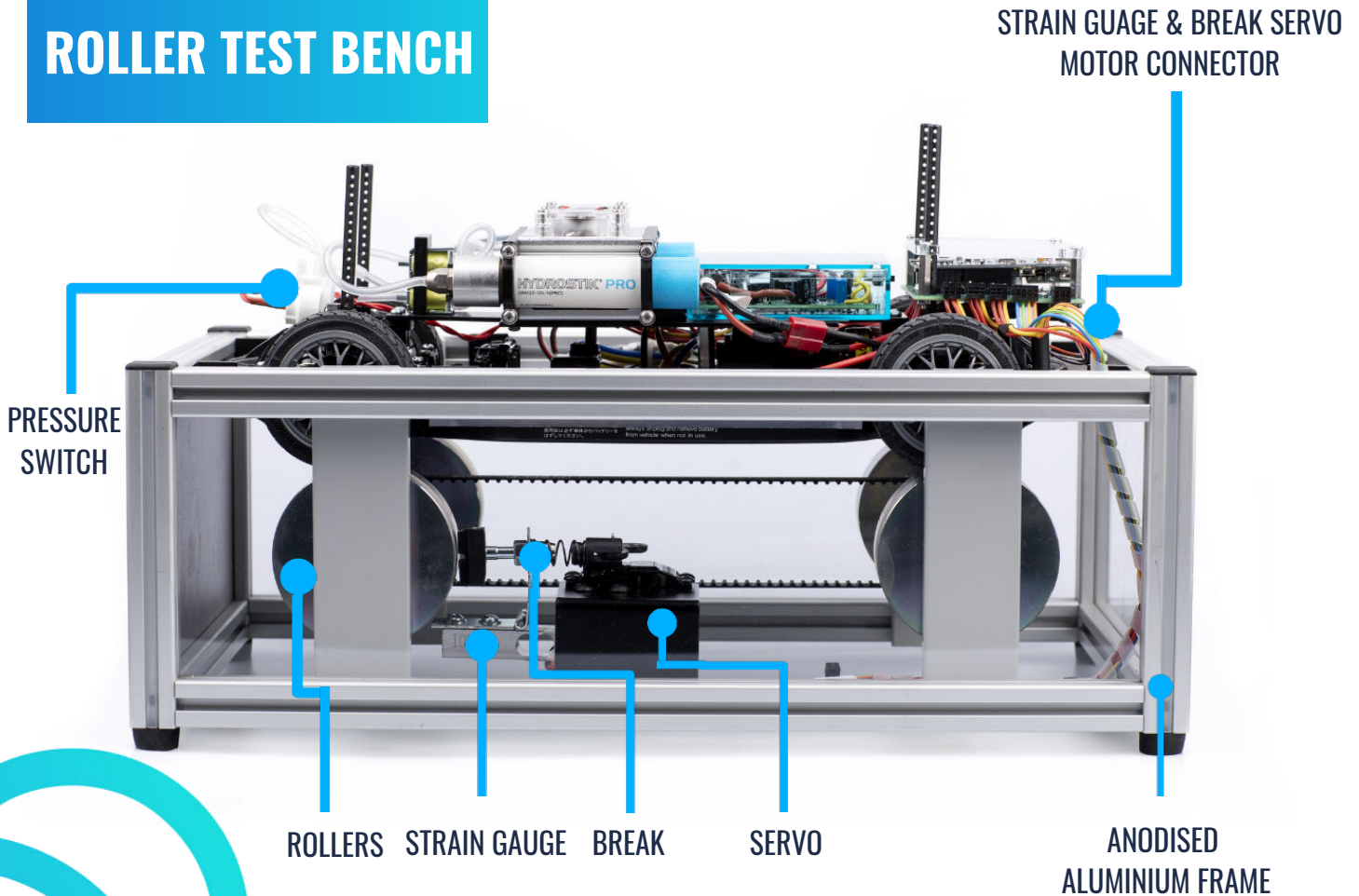

HYDROFILL PRO

- ✓ Produces hydrogen safely
- ✓ Input is just water and electricity
- ✓ Indispensable for HYDROSTIK based engineering

ALSO INCLUDES

- ✓ 2 pressure regulators
- ✓ NiMH battery
- ✓ battery charger





SOFTWARE AND COMPUTER MODELS

- ✓ Modeling for SYSML, PSIM, OpenModelica, MATLAB, and Excel
- ✓ Diagram of a complete Hydrogen Hybrid Car
- ✓ Modeling of energy flow

SYSML

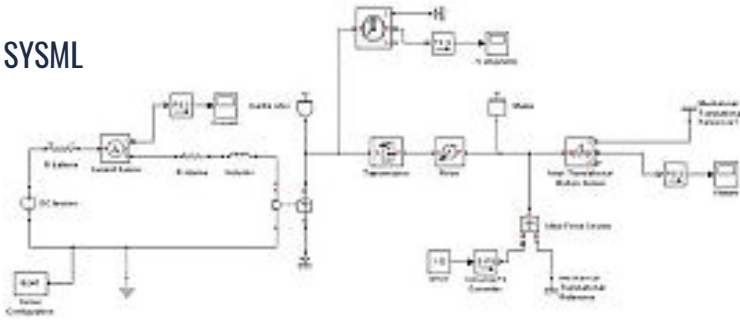

SOLIDWORKS

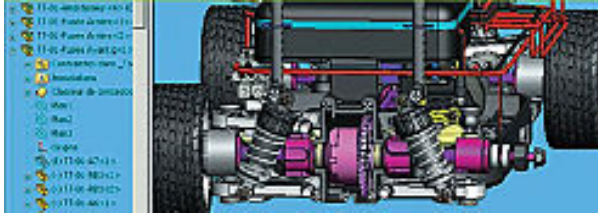

OPENMODELICA

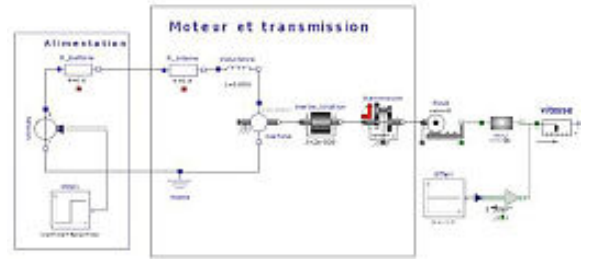

MATLAB

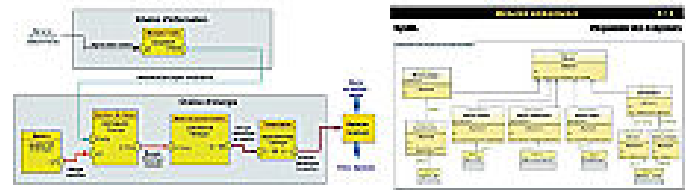

LAB VIEW/HTML WEB SERVER DASHBOARD

- ✓ LabVIEW dashboard with real-time graphs of speed, current, and braking force
- ✓ LabVIEW data collected: speed, battery voltage, fuel cell voltage, current, motor voltage, battery charge
- ✓ HTML WEB server interface connected via wi-fi 

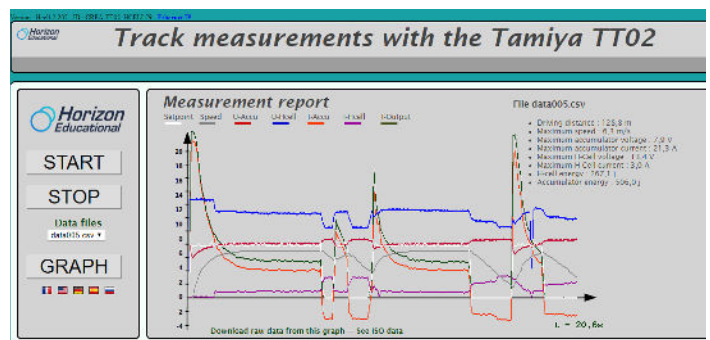



H2Hybrid Fuel Cell Automotive Trainer

LESSON PLANS

- ✓ Students and teachers' material
- ✓ 6 months of curriculum in physics, chemistry and engineering
- ✓ Hands-on experiments and problem based learning



CAR SYSTEMS

Steering and Propulsion
Using Electrical Energy to Power the Vehicle
Transmitting Mechanical Energy
Speed and Consumption of Energy
Measuring Changes in Electrical Energy

ENERGY NEEDS

Using models to describe the car's motion
MATLAB & OpenModelica:
Simulating the car's motion
Making measurements on the track
Making measurements on the charging bench

MANUFACTURER'S DECISION

Making measurements on the track
Making measurements on the charging bench
Energy consumption
Sustainable development

THE ROLE OF HYDROGEN

Understanding the hydrogen fuel cell
Understanding modern batteries
Comparing sources of electricity

SYSTEM ADAPTABILITY

Providing power
H-Cell power
Influence of the arrangement of the components of the fuel cell
Effects of the arrangement of the Hydrostiks

CUSTOMIZING YOUR CAR

Changing how you drive
Changing the components of the energy system of the car
Reducing various forms of resistance to motion
Changing the mode of hydrogen consumption





H2Hybrid Fuel Cell Automotive Trainer

DATASHEET



30W FUEL CELL STACK



FCAT-30 SET

Type of Fuel Cell	PEM
Number of Cells	14
Rated power	30W
Rated performance	8.4V@3.6A
Purging valve voltage	6V
Blower voltage	5V
Reactants	Hydrogen and Air
Ambient temperature	50-30°C (41-86°F)
Max stack temperature	55°C (131°F)
Hydrogen pressure	0.45-0.55 Bar
Humidification	Self-humidified
Cooling	Air (integrated cooling fan)
Stack weight (with fan&casing)	280g (±30g)
Stack size	80x47x75mm
Flow rate at max output	0.42L/min
Hydrogen purity	≥99.995% dry H2
Start up time	≤30s (ambient temp.)
Efficiency of system	40% at full power

CONTROLLER BOARD



Controller weight 90g(±10g)

HYDROGEN STORAGE HYDROSTIK PRO



Capacity	10L hydrogen
Hydrogen purity	≥99.995%
Cartridge size	Ø22x88mm
Weight	Approx. 105g
Storage material	AB5 metal hydride
Rated charging pressure	3.0 MPa
Working temperature	0-55°C (0-131°F)
Service life	10 years

HYDROFILL PRO



Stack type	PEM electrolysis cell
Dimensions (WxDxH)	145x153x208 mm (5.7x6x8.2in)
Weight	1.8kg ±5% (3.97Lbs ±5%)
Rated power	≤23W
Input voltage	DC: 10V-19V
Water input	De-ionised or distilled water
Water temperature	10-40°C (50-104°F)
Water consumption	Approx. 20ml/hr (1.2in3 /hr)
H2 output pressure	0-3.0 MPaG (0-435.11 PSI)
H2 generation capacity	Up to 3L/hr (0-183in /hr)
Purity	99.995%
Compatible cartridge	HYDROSTIK & HYDROSTIK PRO
Refilling time for one	Around 4 hours

OTHER COMPONENTS

- Hybrid power management module
- LabVIEW software dashboard
- HTML WEB server dashboard
- SD Card
- Roller test bench

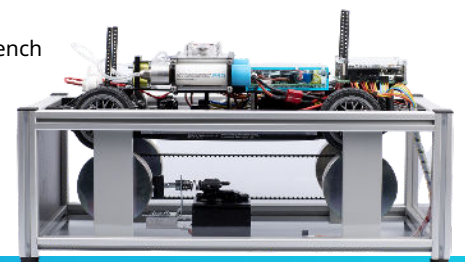



Complete resources for advanced experiments

FCAT-30 SET

DATASHEET



MONITORING BOARD WITH ARDUINO YUN

- 3 inputs Current measurement 0-20A
- 3 inputs Voltage measurement 0-13V
- 1 input PWM
- 1 input Incremental encodEUR
- 2 outputs PWM
- Connection WiFi, MicroUSB and Ethernet 100Mb

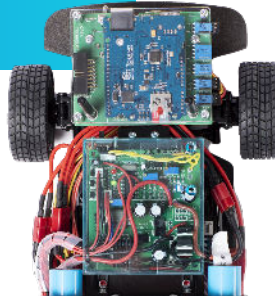

NIMH BATTERY

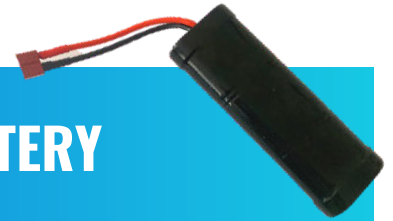

- Output voltage 7.2V
- Capacity 3300mAh
- Weight 0.31kg



ONE STEP PRESSURE REGULATOR 2X

- Weight 27.6g
- Screw type M6
- Size $\Phi 22 \times 38\text{mm}$
- Max. input pressure 30Bar
- Output pressure 0.4-0.55Bar
- Hydrogen flow rate 0-8L/min
- Materials plastic/copper/aluminum
- Sealing material Propionitrile rubber



BATTERY CHARGER

- Input AC 100-240V, 50/60Hz
- Output max. 16W, 2A
- Weight 0.13kg

The H2Hybrid Fuel Cell Automotive Trainer is the ultimate tool for exploring science and engineering concepts through hands-on activities with a working fuel cell car. An impressive array of hardware, software, and digital curricular materials allow for hours of activities for students of everything from high school vocational-technical up through college-level engineering.



HORIZON ENERGY CURRICULUM

STUDENT'S & TEACHER'S MATERIALS

EASY TO DOWNLOAD

